

**ALMAPROIN, S.A.**

Av. Ciudad de Barcelona, 57  
28007 Madrid - España  
+34 91 433 53 98 [almaproin@almaproin.com](mailto:almaproin@almaproin.com)  
[www.almaproin.com](http://www.almaproin.com)



## Capacidad de carga:

La capacidad de carga de un rodamiento es definida como coeficiente C y medida en daN. Los ensayos se rigen por las siguientes premisas:

- 200 mm longitud del rodillo (Rodillo corto)
- Eje sujetado
- Velocidad 100min<sup>-1</sup> - 200min<sup>-1</sup>
- 1.000.000 vueltas (carga alternada)

## Duración:

Mediante la siguiente fórmula se puede deducir de la capacidad de carga la duración del rodamiento:

$$Lh = \frac{1000000}{60 \times n} \left( \frac{C}{P} \right)^p$$

- Lh: Duración nominal [h]  
C: Coeficiente de carga dinámica [N]  
n: Número de vueltas [min<sup>-1</sup>]  
P: Carga dinámica del rodamiento [N]  
(P = C con carga estrictamente radial)  
p: Exponente de la ecuación de duración  
(para rodamientos: p=3)

## Termoplásticos:

Polipropileno (PP)

- buenas propiedades mecánicas
- excelente resistencia a choques

Poliacetal (POM)

- alta dureza y rigidez
- poca absorción de humedad
- buenas propiedades ante fricción y desgaste

Polipropileno (PA)

- correoso y duro al mismo tiempo
- excelentes propiedades mecánicas y resistente a la abrasión

Plásticos antiestáticos

- PP
- POM

El empleo de plásticos antiestáticos, solo resulta efectivo dentro del margen de temperatura previsto para ello. No garantizamos una determinada conductividad.

**Atención: !!!No indicado en áreas ATEX !!!**

## Factores de alteración:

Cuando cambien las premisas [anteriormente establecidas], habrá que redefinir la capacidad de carga. Hay que tener en cuenta que tanto la capacidad de carga como la duración de un rodillo dependen, entre otros, de:

- Longitud del rodillo
- Diámetro del eje
- Tipo de eje
- Propiedades del entorno

## Influencia long. rodillo s/ capacidad carga:

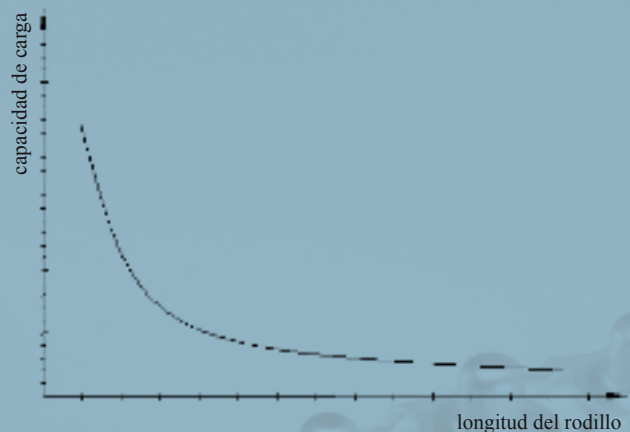

## Lubricantes:

Nuestros rodamientos están equipados con lubricantes de alta calidad. Además, gracias a la disponibilidad de una amplia gama de grasas y aceites especiales, estamos en condiciones de ofrecer nuestro producto para el empleo en temperaturas entre -35° C hasta +180° C. Nuestros lubricantes, probados durante muchos años, han dado los mejores resultados en las condiciones de trabajo más difíciles. Recomendamos a nuestros clientes que nos consulten acerca de lubricaciones específicas, individualmente aconsejadas.

**Cabezales de Plástico KTR/KTE hasta 150 daN**



**KTR/KTE**

## Cabezales de Plástico KTR/KTE

- Montaje a presión (KTR) o para embutir (KTE)
- Rodamiento de embutición (MAN) o de precisión (según norma DIN)
- Propiedades / Aplicaciones:
  - MAN: Marcha ligera (a gravedad); carga axial tolerada  
velocidad hasta 200 rpm
  - DIN: Indicado para rodillos propulsados y para carga pesada; marcha silenciosa
- Modelos especiales (material antiestático, lubricación específica o presentaciones individuales) a consultar

# KTR/KTE

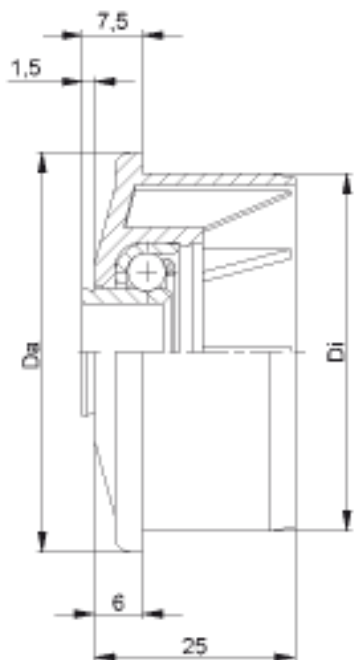

| KTR-25        |         |      |                         |
|---------------|---------|------|-------------------------|
| Tipo          | Di +0,2 | Da   | carga máxima<br>C [daN] |
| KTR-40x3,0.25 | 34,3    | 39,9 | 50                      |
| KTR-50x1,5.25 | 47,3    | 49,9 | 50                      |
| KTR-50x2,8.25 | 44,6    | 49,9 | 50                      |

**Otras medidas a consultar!**

- ☛ Cazoleta: Plástico
- ☛ Cojinete RL-25
  - ☛ Alojamiento de bolas: Acero templado
  - ☛ Buje: Acero templado y cincado
  - ☛ Jaula: Plástico
  - ☛ Bolas: Acero

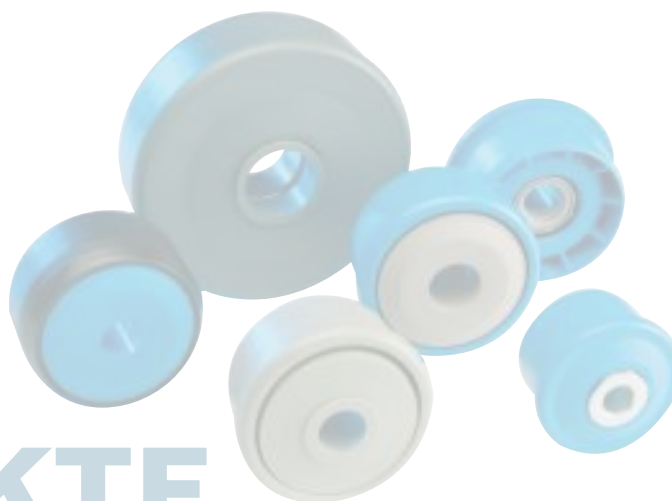

**KTR-25**

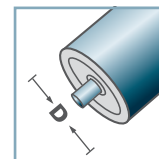

**D** [mm]  
40 - 50

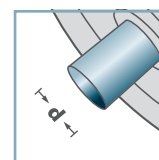

**d** [mm]  
8; 10; 12

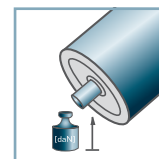

**C** [daN]  
50

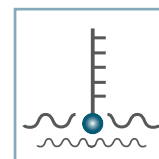

**T** [°C]  
0° - 80°



Vactra No. 2



**Envase** [pzs.]

ø40: 400  
ø50: 250

**KTR/KTE**

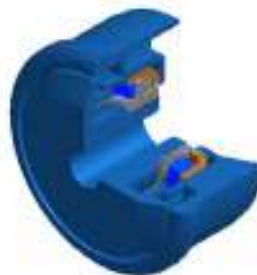
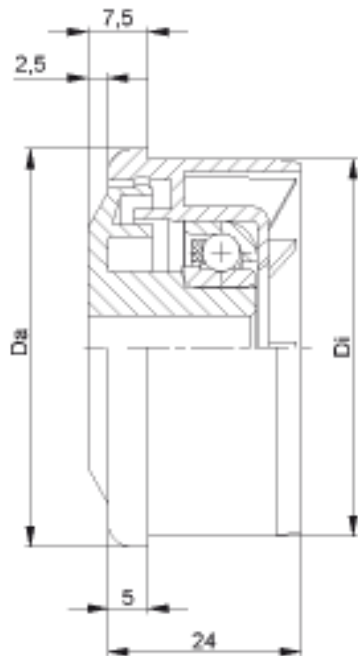

| KTR-30        |         |      |                         |
|---------------|---------|------|-------------------------|
| Tipo          | Di +0,2 | Da   | carga máxima<br>C [daN] |
| KTR-50x1,5.30 | 47,3    | 49,9 | 80                      |
| KTR-50x2,8.30 | 44,6    | 49,9 | 80                      |
| KTR-60x1,5.30 | 57,3    | 59,9 | 80                      |

**Otras medidas a consultar!**

- ☛ Cazoleta: Plástico
- ☛ Tapa-laberinto: Plástico
- ☛ Cojinete RL-30
  - ☛ Alojamiento de bolas: Acero templado
  - ☛ Buje: Acero templado
  - ☛ Jaula: Plástico
  - ☛ Bolas: Acero

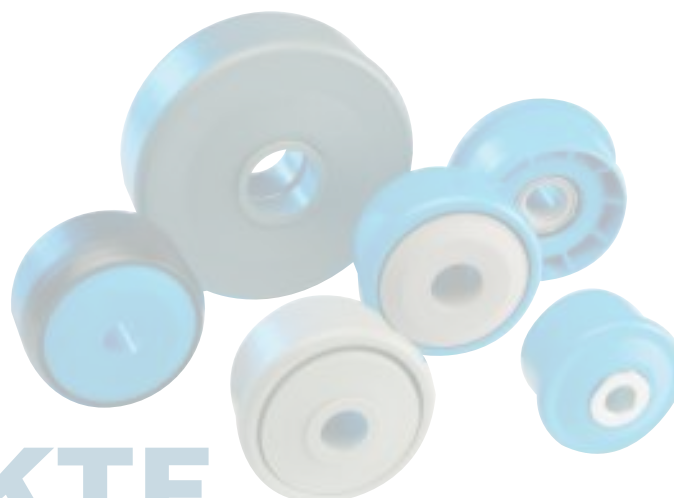

**KTR-30**

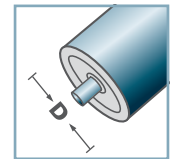

**D** [mm]  
50 - 60

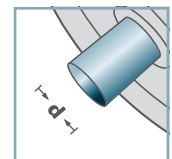

**d** [mm]  
10; 12; 14; 15;  
SW11

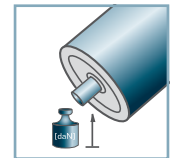

**C** [daN]  
80

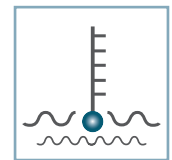

**T** [°C]  
0° - 80°



Vactra No. 2



**Envase** [pzs.]

ø50: 250  
ø60: 200

**KTR/KTE**

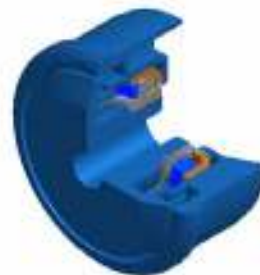
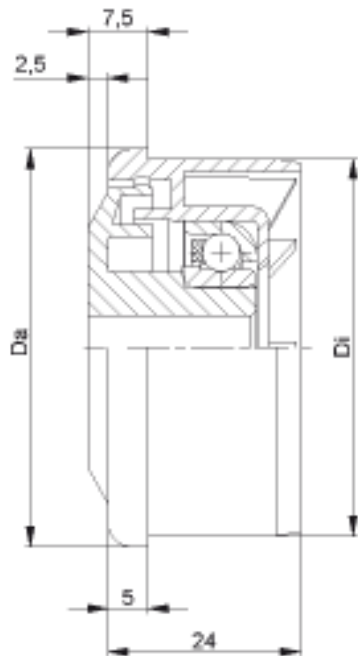

| KTR-31        |         |      |                         |
|---------------|---------|------|-------------------------|
| Tipo          | Di +0,2 | Da   | carga máxima<br>C [daN] |
| KTR-50x1,5.31 | 47,3    | 49,9 | 25                      |
| KTR-50x2,8.31 | 44,6    | 49,9 | 25                      |
| KTR-60x1,5.31 | 57,3    | 59,9 | 25                      |

**Otras medidas a consultar!**

- ☛ Cazoleta: Plástico
- ☛ Tapa-laberinto: Plástico
- ☛ Cojinete RL-31
  - ☛ Alojamiento de bolas: INOX 1.4301
  - ☛ Buje: INOX 1.4305
  - ☛ Jaula: Plástico
  - ☛ Bolas: INOX 1.4301

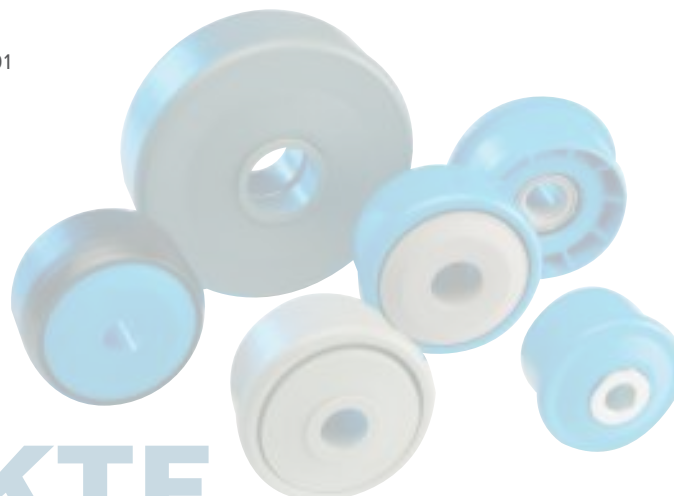

**KTR-31**

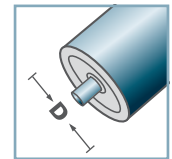

**D** [mm]  
50 - 60

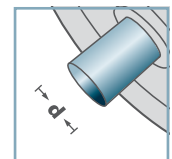

**d** [mm]  
10; 12; 14; 15;  
SW11

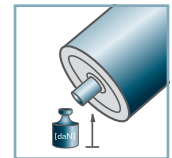

**C** [daN]  
25

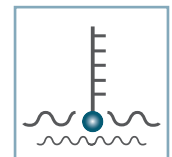

**T** [°C]  
0° - 80°



Vactra No. 2



**Envase** [pzs.]

ø50: 250  
ø60: 200

**KTR/KTE**

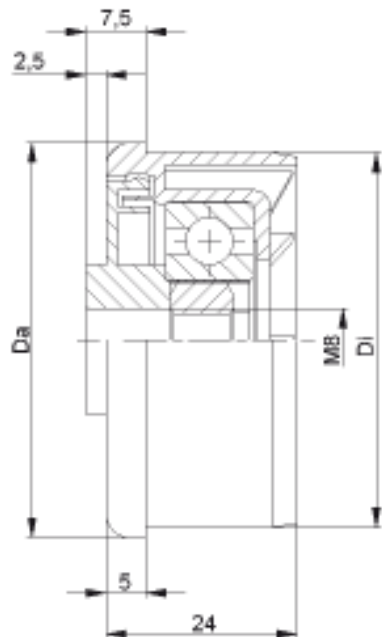

| KTR-40.M8     |         |      |                         |
|---------------|---------|------|-------------------------|
| Tipo          | Di +0,2 | Da   | carga máxima<br>C [daN] |
| KTR-50x1,5.40 | 47,3    | 49,9 | 80                      |
| KTR-60x1,5.40 | 57,3    | 59,9 | 80                      |

**Otras medidas a consultar!**

- ☛ Cazoleta: Plástico
- ☛ Tapa-laberinto: Plástico
- ☛ Cojinete 6202
- ☛ Tuerca hexagonal

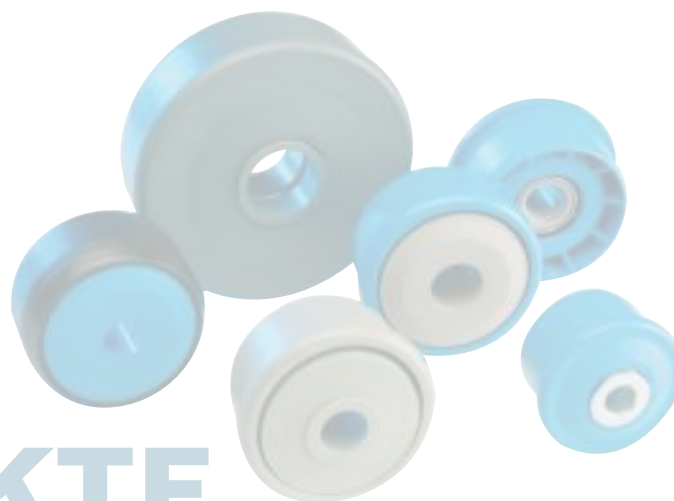

**KTR-40.M8**

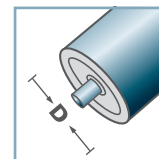

**D** [mm]  
50 - 60

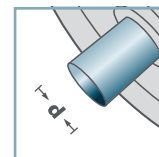

**d** [mm]  
M8

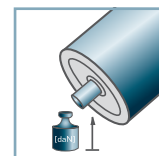

**C** [daN]  
80

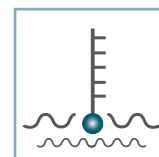

**T** [°C]  
0° - 80°



EP 2



**Envase** [pzs.]

ø50: 250  
ø60: 100

**KTR/KTE**

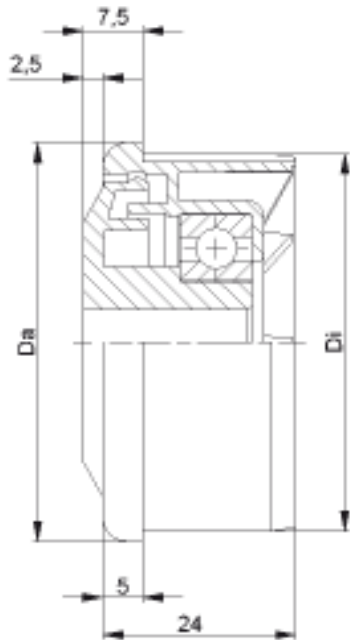

| KTR-42        |          |      |                         |
|---------------|----------|------|-------------------------|
| Tipo          | Di +0,25 | Da   | carga máxima<br>C [daN] |
| KTR-40x1,5.42 | 37,2     | 39,9 | 80                      |
| KTR-50x1,5.42 | 47,3     | 49,9 | 80                      |
| KTR-50x2,0.42 | 46,3     | 49,9 | 80                      |
| KTR-50x2,8.42 | 44,6     | 49,9 | 80                      |
| KTR-60x1,5.42 | 57,3     | 59,9 | 80                      |
| KTR-60x2,0.42 | 56,3     | 59,9 | 80                      |

**Otras medidas a consultar!**

- ☑ Cazoleta: Plástico
- ☑ Tapa-laberinto: Plástico
- ☑ Cojinete 6002

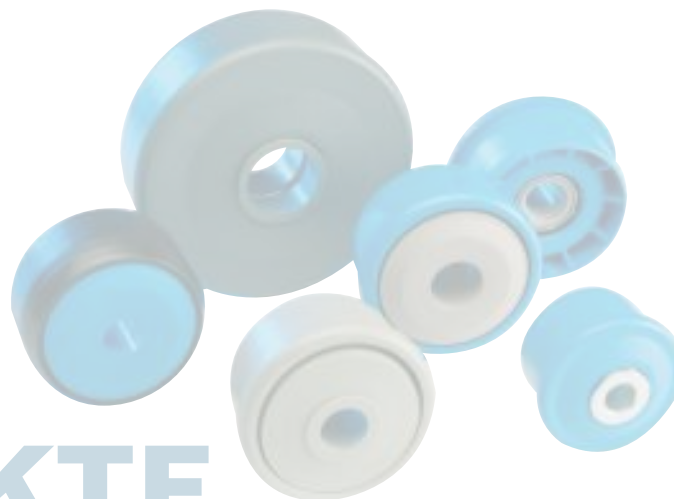

**KTR-42**

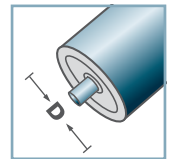

**D** [mm]  
40 - 60

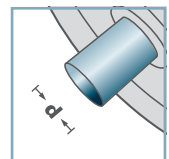

**d** [mm]  
10; 12; 14; 15;  
SW11

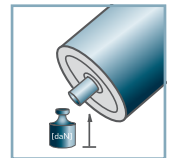

**C** [daN]  
80

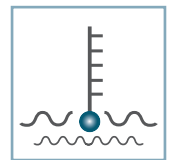

**T** [°C]  
0° - 80°



EP 2



**Envase** [pzs.]

ø50: 250  
ø60: 100

**KTR/KTE**

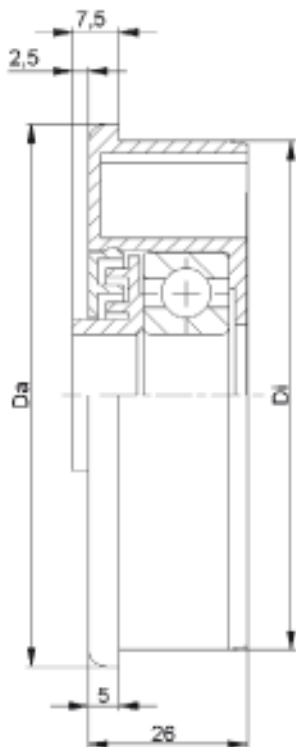

| KTR-44        |         |      |                         |
|---------------|---------|------|-------------------------|
| Tipo          | Di +0,2 | Da   | carga máxima<br>C [daN] |
| KTR-89x3,0.44 | 83,3    | 88,9 | 150                     |

**Otras medidas a consultar!**

- ☛ Cazoleta: Plástico
- ☛ Laberinto interior: Plástico
- ☛ Laberinto exterior: Plástico
- ☛ Cojinete 6204

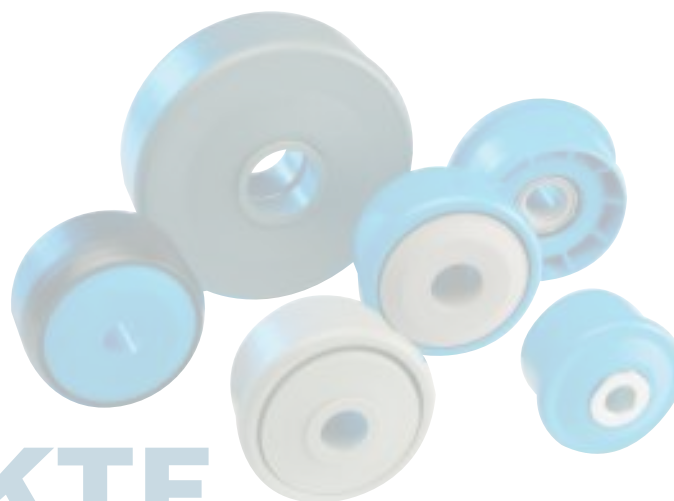

**KTR-44**

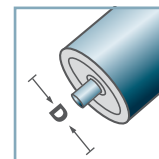

**D** [mm]  
89

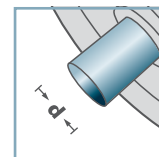

**d** [mm]  
20

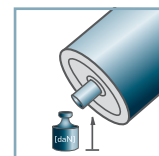

**C** [daN]  
150

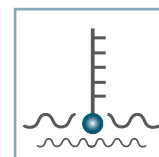

**T** [°C]  
0° - 80°



EP 2



**Envase** [pzs.]

80

**KTR/KTE**

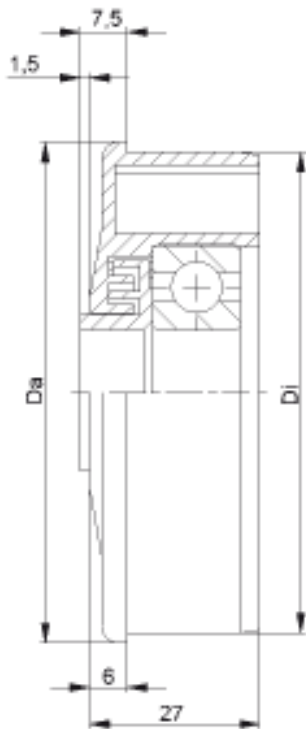

| KTR-43/44           |         |      |                         |
|---------------------|---------|------|-------------------------|
| Tipo                | Di +0,2 | Da   | carga máxima<br>C [daN] |
| KTR-63,5x2,9.43/.44 | 58,0    | 63,4 | 150                     |
| KTR-80x2,0.43/.44   | 76,4    | 79,9 | 150                     |

**Otras medidas a consultar!**

- ☛ Cazoleta: Plástico
- ☛ Tapa-laberinto: Plástico
- ☛ Cojinete 6303/6204

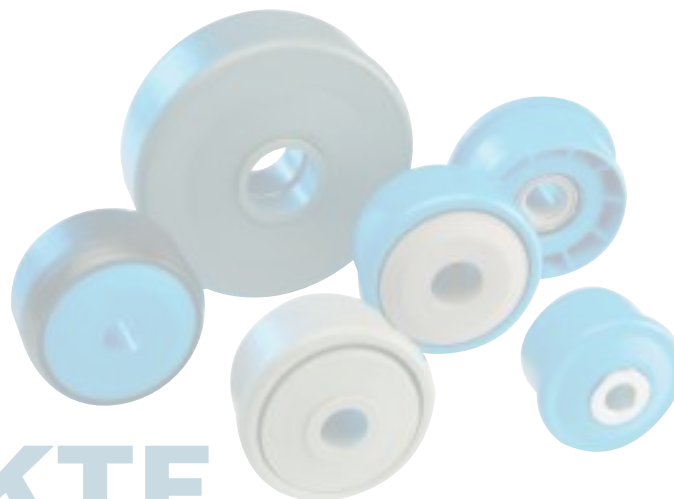

**KTR-43/44**

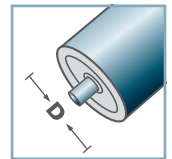

**D** [mm]  
63,5 - 80

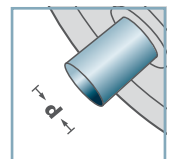

**d** [mm]  
6303: 17  
6204: 20

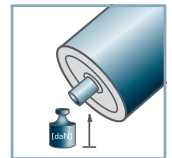

**C** [daN]  
150

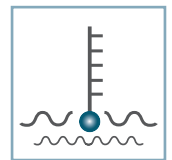

**T** [°C]  
0° - 80°



EP 2



**Envase** [pzs.]

100

**KTR/KTE**

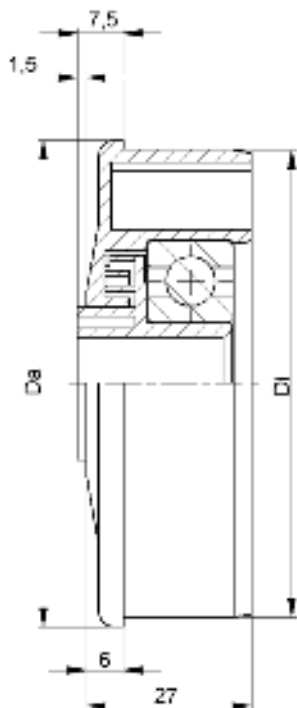

**KTR-43/44**

| Tipo                | Di +0,2 | Da   | carga máxima<br>C [daN] |
|---------------------|---------|------|-------------------------|
| KTR-63,5x2,9.43/.44 | 58,0    | 63,4 | 150                     |
| KTR-80x2,0.43/.44   | 76,4    | 79,9 | 150                     |

**Otras medidas a consultar!**

- ☛ Cazoleta: Plástico
- ☛ Tapa-laberinto: Plástico
- ☛ Cojinete 6303/6204

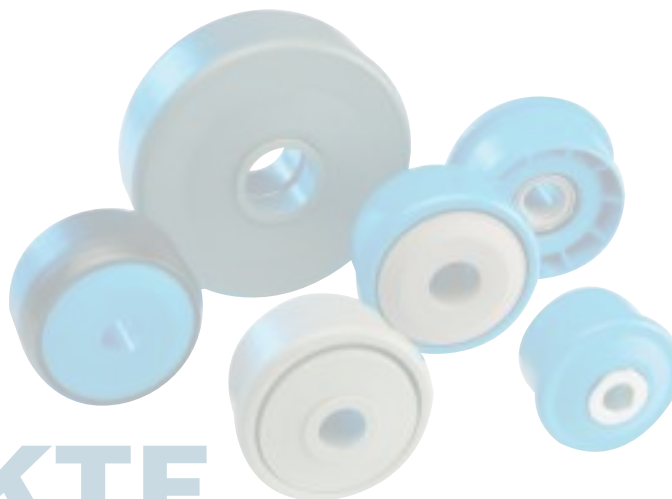

**KTR-43/44**

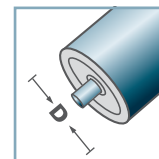

**D** [mm]  
63,5 - 80

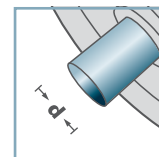

**d** [mm]  
6303: 12  
6204: 15

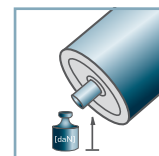

**C** [daN]  
150

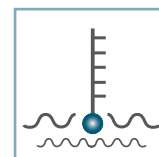

**T** [°C]  
0° - 80°



EP 2



**Envase** [pzs.]

100

**KTR/KTE**

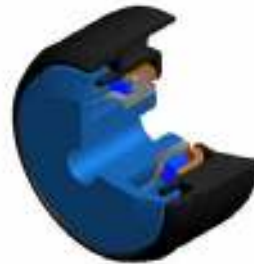
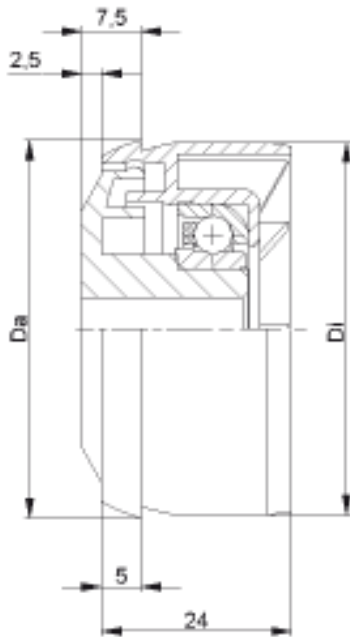

| KTE-30        |         |      |                         |
|---------------|---------|------|-------------------------|
| Tipo          | Di +0,3 | Da   | carga máxima<br>C [daN] |
| KTE-50x1,5.30 | 47,1    | 47,9 | 80                      |

**Otras medidas a consultar!**

- ☛ Cazoleta: Plástico
- ☛ Tapa-laberinto: Plástico
- ☛ Cojinete RL-30
  - ☛ Alojamiento de bolas: Acero templado
  - ☛ Buje: Acero templado
  - ☛ Jaula: Plástico
  - ☛ Bolas: Acero

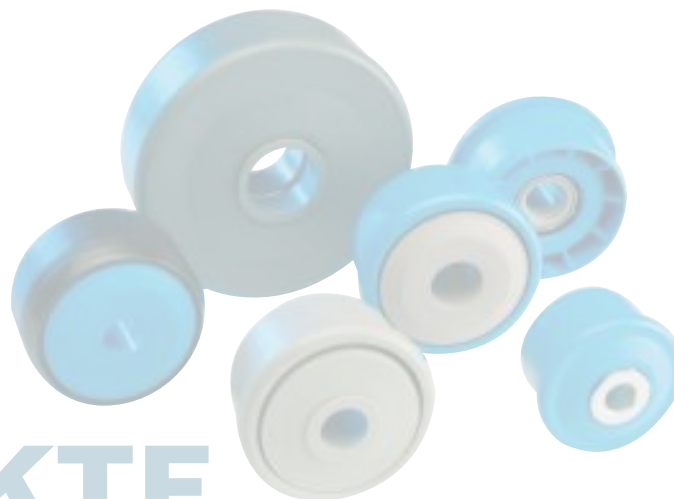

**KTE-30**

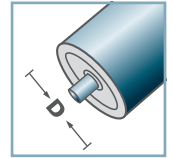

**D** [mm]  
50

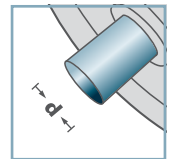

**d** [mm]  
10; 12; 14; 15;  
SW11

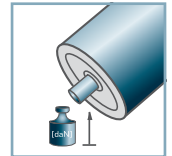

**C** [daN]  
80

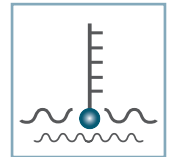

**T** [°C]  
0° - 80°



Vactra No. 2



Envase [pzs.]

250

**KTR/KTE**

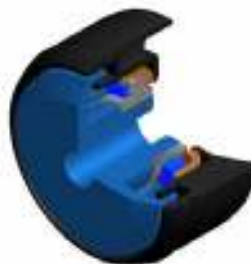
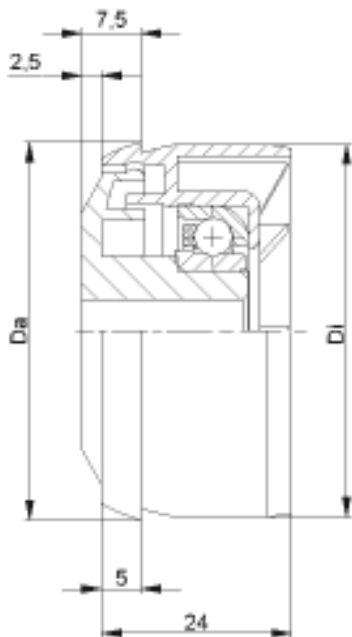

**KTE-31**

| Tipo          | Di +0,3 | Da   | carga máxima<br>C [daN] |
|---------------|---------|------|-------------------------|
| KTE-50x1,5.31 | 47,1    | 47,9 | 25                      |

**Otras medidas a consultar!**

- ☛ Cazoleta: Plástico
- ☛ Tapa-laberinto: Plástico
- ☛ Cojinete RL-31
  - ☛ Alojamiento de bolas: INOX 1.4301
  - ☛ Buje: INOX 1.4305
  - ☛ Jaula: Plástico
  - ☛ Bolas: INOX 1.4301

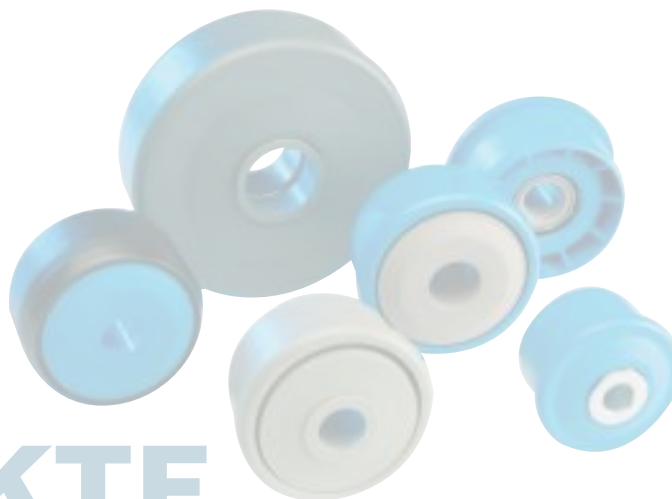

**KTE-31**

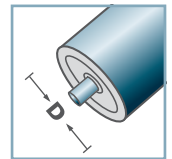

**D** [mm]  
50

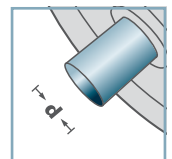

**d** [mm]  
10; 12; 14; 15;  
SW11

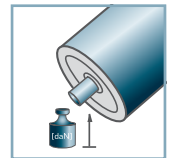

**C** [daN]  
25

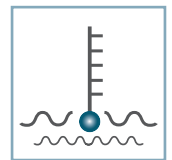

**T** [°C]  
0° - 80°



Vactra No. 2



Envase [pzs.]

250

**KTR/KTE**

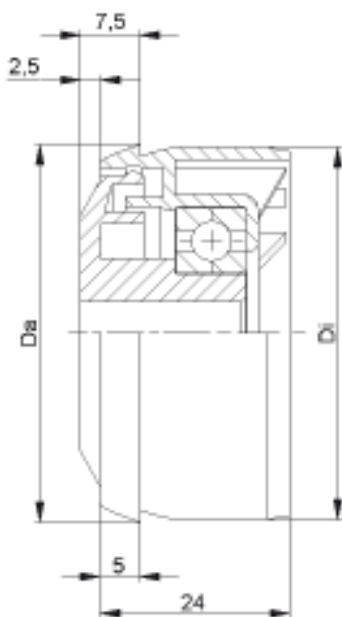

| KTE-42        |         |      |                         |
|---------------|---------|------|-------------------------|
| Tipo          | Di +0,3 | Da   | carga máxima<br>C [daN] |
| KTE-50x1,5.42 | 47,1    | 47,9 | 80                      |

**Otras medidas a consultar!**

- ☛ Cazoleta: Plástico
- ☛ Tapa-laberinto: Plástico
- ☛ Cojinete 6002

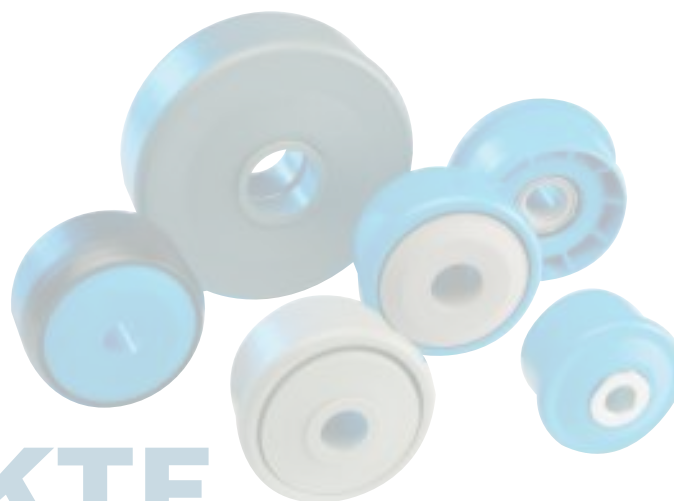

**KTE-42**

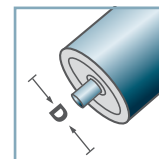

**D** [mm]  
50

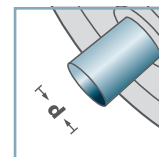

**d** [mm]  
10; 12; 14; 15;  
SW11

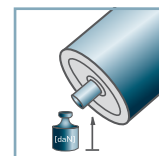

**C** [daN]  
80

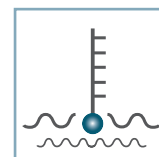

**T** [°C]  
0° - 80°



EP 2



**Envase** [pzs.]

250

**KTR/KTE**